

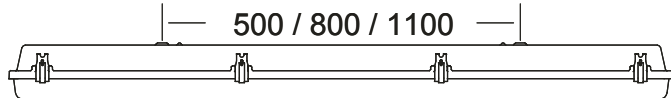

Led

Installation instructions IP65/67

Instructions de montage
Montageanleitung
Montage instruktie



IP65

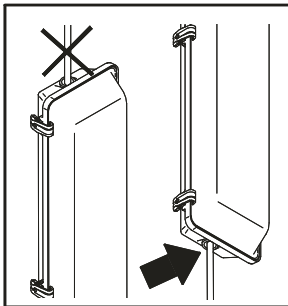
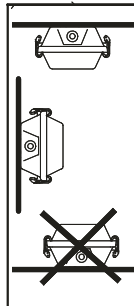
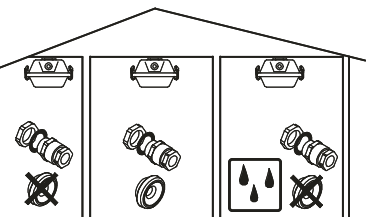

1 IP65 IP67

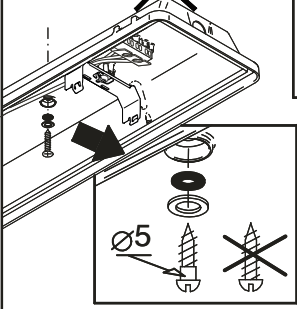

or
ou
oder
of

IP67

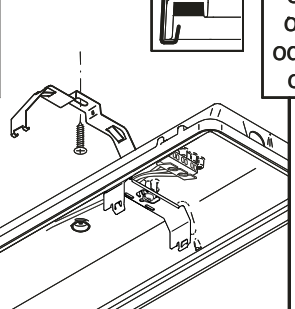

or
ou
oder
of

IP67

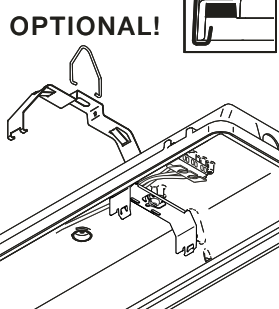

OPTIONAL!

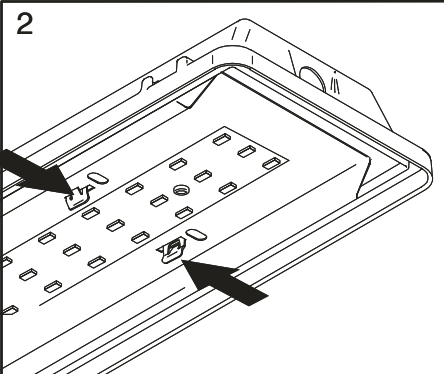

Maintenance only by qualified personnel.
Do NOT touch LED's!
Entretien seulement par un technicien qualifié
Ne pas toucher les LED's!
Wartung durch qualifiziertes Fachpersonal.
LED's nicht berühren!

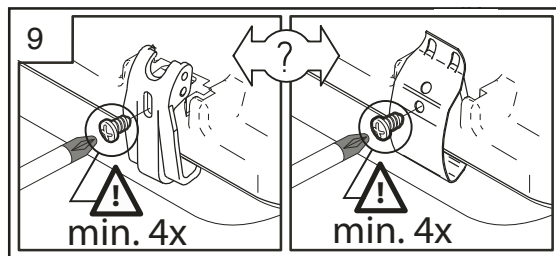
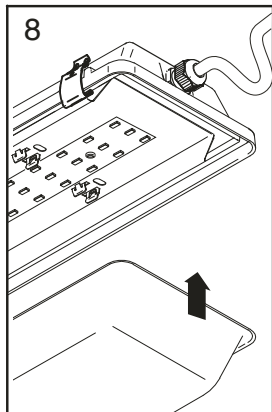
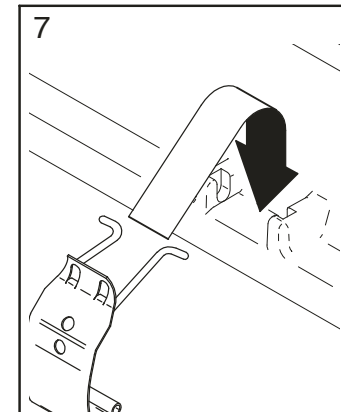
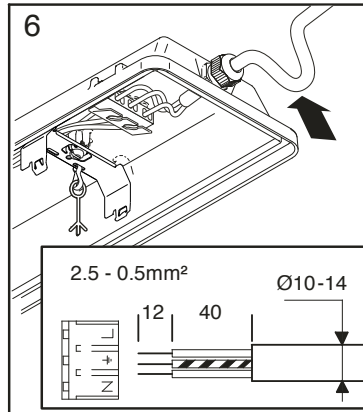
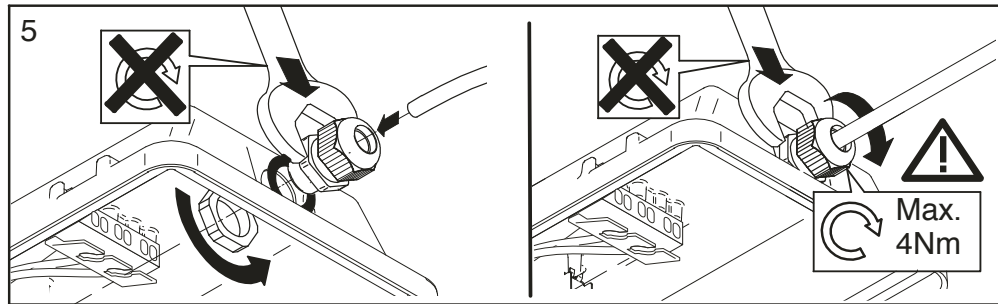
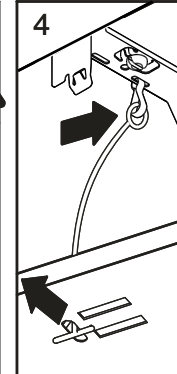
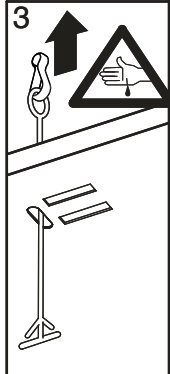

The light source contained in this luminaire shall only be replaced by the manufacturer or his service agent or a similar qualified person.
La source lumineuse contenue dans ce luminaire ne doit être remplacée que par le fabricant ou son agent de service ou une personne qualifiée similaire.
Die in dieser Leuchte enthaltene Lichtquelle darf nur vom Hersteller oder seinem Kundendienst oder einer ähnlich qualifizierten Person ersetzt werden.

NOTICE sur l'application du luminaire. Ce luminaire est conçu pour un usage intérieur ou extérieur (sous abri). La résistance de ce luminaire aux produits chimiques ou à un environnement contenant ces produits peut être limitée ou même nulle. Avant d'utiliser des détergents agressifs, désinfectants ou d'installer le luminaire dans un local dont l'atmosphère chimique est douteuse (comme les car-wash, piscines, cuisines industrielles, blanchisseries industrielles, abattoirs, etc. ...), ou en cas de doute, veuillez contacter votre distributeur. Pour certaines de ces conditions, des produits appropriés sont disponibles. Ne pas nettoyer sous haute pression.

NOTICE on application of the luminaire. This luminaire is suitable for indoor and outdoor use (not directly exposed). The resistance of this luminaire against chemical products or environments containing these may be limited or even nil. Before using aggressive detergents, disinfectants or installing the luminaire in hazardous areas (as car washes, swimming pools, industrial kitchens, industrial laundries, slaughterhouses, etc ...) or in case of doubt, please contact your distributor. For some of these conditions, appropriate products are available. Do not clean under high pressure.

